

TECHNICAL DATA

Power	6,0 - 9,0 W
Operating voltage	24 V DC
Type of luminaire	Light strip
LED Type	SMD
Control	PWM
Light efficiency	up to 120 lm/W
Colour consistency	SDCM3
Lifetime	L80 B10 60.000 h @ 10°C L80 B10 50.000 h @ 25°C
Ambient temperature	-30°C to +25°C
Material	Aluminium
Cascading	yes
Warranty	5 Years



TYPES



DIMENSIONS (mm)

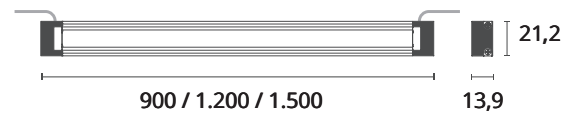

BEAM ANGLE

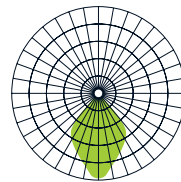

HIGHLIGHTS

- cost effective retrofit system
- especially for refrigerated cabinets -30° to +25° (IP 44)
- flexible integration with multiple accessories
- brilliant light with CRI 94
- installation: via magnet or screw clip
- splash water protected socket connectors (both sides)

APPLICATIONS SCL-G2-C

Mounting in the furniture head, for illumination of the upper shelves.

- Refrigerated multideck cabinet (open / closed)
- Freezer
- Combi Freezer



STANDARDS SCL-G2-SERIES

IEC 60598-1-2014

IEC 60598-1-2014/AMD1:2017

IEC 60598-2-1-2020

IEC 60335-1-2010

IEC 60335-1-2010/AMD1:2013

IEC 60335-1-2010/AMD2:2016

IEC 60335-2-89:2010

IEC 60335-2-89:2010/AMD1:2012

IEC 60335-2-89:2010/AMD2:2015

Item number	Productcode	Power	Light colour Ledxon	CRI	Luminous flux	Beam characteristic	Length	Casca ding	Weight
9100961	SCL-G2-L900-930-C	6 W	3000 K	94	690 lm	Canopy	890 mm	16	0,30 kg
9100962	SCL-G2-L900-940-C	6 W	4000 K	94	720 lm	Canopy	890 mm	16	0,30 kg
9100963	SCL-G2-L900-957-C	6 W	5700 K	94	720 lm	Canopy	890 mm	16	0,30 kg
9100964	SCL-G2-L900-FM-C	6 W	Fresh meat	90	570 lm	Canopy	890 mm	16	0,30 kg
9100965	SCL-G2-L1200-930-C	7,5 W	3000 K	94	863 lm	Canopy	1196 mm	12	0,41 kg
9100966	SCL-G2-L1200-940-C	7,5 W	4000 K	94	900 lm	Canopy	1196 mm	12	0,41 kg
9100967	SCL-G2-L1200-957-C	7,5 W	5700 K	94	900 lm	Canopy	1196 mm	12	0,41 kg
9100968	SCL-G2-L1200-FM-C	7,5 W	Fresh meat	90	713 lm	Canopy	1196 mm	12	0,41 kg
9100969	SCL-G2-L1500-930-C	9 W	3000 K	94	1035 lm	Canopy	1482 mm	9	0,51 kg
9100970	SCL-G2-L1500-940-C	9 W	4000 K	94	1080 lm	Canopy	1482 mm	9	0,51 kg
9100971	SCL-G2-L1500-957-C	9 W	5700 K	94	1080 lm	Canopy	1482 mm	9	0,51 kg
9100972	SCL-G2-L1500-FM-C	9 W	Fresh meat	90	855 lm	Canopy	1482 mm	9	0,51 kg

TECHNICAL DATA

Power	13,2 - 21,6 W
Operating voltage	24 V DC
Type of luminaire	Light strip
LED Type	SMD
Control	BT
Light efficiency	up to 120 lm/W
Colour consistency	SDCM3
Lifetime	L80 B10 60.000 h @ 10°C L80 B10 50.000 h @ 25°C
Ambient temperature	-30°C to +25°C
Material	Aluminium
Cascading	no
Warranty	5 Years



TYPES

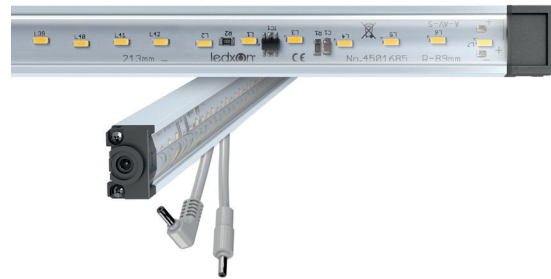

DIMENSIONS (mm)

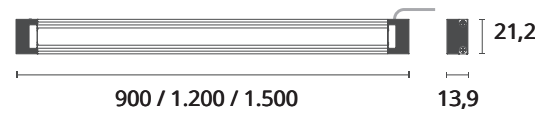

BEAM ANGLE

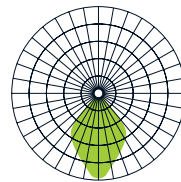

HIGHLIGHTS

- no WLAN necessary
- Mesh-function
- timer
- group function
- scenes
- password protected
- no additional dimmer necessary

APPLICATIONS SCL-G2-C - BT

Mounting in the furniture head, for illumination of the upper shelves.

- Refrigerated multideck cabinet (open / closed)
- Freezer
- Combi Freezer



LIGHTMANAGEMENT

Download our App: eyeconex LIGHTMANAGEMENT

- lighting control via BT

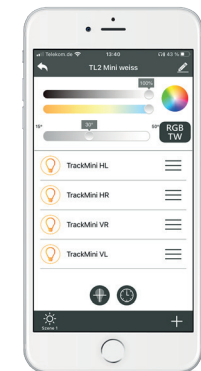

Item number	Productcode	Power	Light colour Ledxon	CRI	Luminous flux	Beam characteristic	Length	Weight
9100990	SCL-G2-L900-940-FM-C-BT	13,2 W	4000 K - Fresh meat	94	1584 lm	Canopy	890 mm	0,30 kg
9100991	SCL-G2-L1200-940-FM-C-BT	18 W	4000 K - Fresh meat	94	2160 lm	Canopy	1196 mm	0,41 kg
9100708	SCL-G2-L1500-940-FM-C-BT	21,6 W	4000 K - Fresh meat	94	2592 lm	Canopy	1482 mm	0,51 kg
9100709	SCL-G2-L900-930-957-C-BT	13,2 W	3000 K - 5700 K	94	1584 lm	Canopy	890 mm	0,30 kg
9100710	SCL-G2-L1200-930-957-C-BT	18 W	3000 K - 5700 K	94	2160 lm	Canopy	1196 mm	0,41 kg
9100711	SCL-G2-L1500-930-957-C-BT	21,6 W	3000 K - 5700 K	94	2592 lm	Canopy	1482 mm	0,51 kg

ACCESSORIES

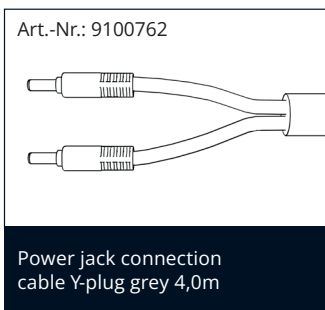
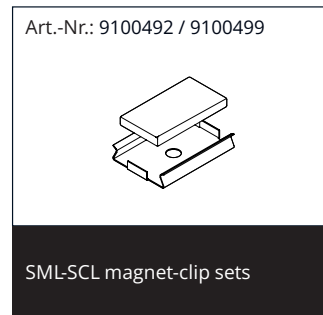
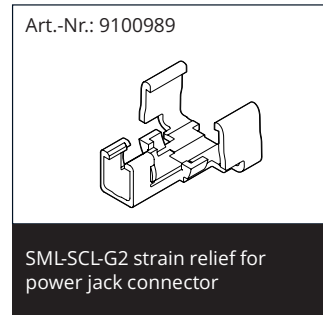
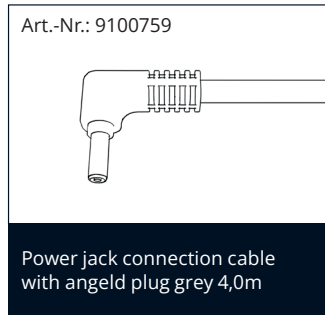
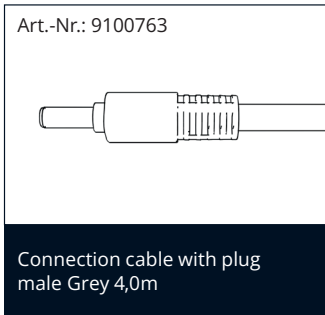

Item description	Item number
Connection cable with plug male grey 4,0m (for LCR-SCL-SML)	9100763
Power jack connection cable with angled plug grey 4,0m (for LCR-SCL-SML)	9100759
Power jack connection cable female grey 4,0m (for LCR-SCL-SML)	9100764
Power jack connector double male grey 0,15m (for LCR-SCL-SML)	9100766
Power jack connection cable Y-plug grey 4,0m (for LCR-SCL-SML)	9100762
Power jack sealing cap grey (for LCR-SCL-SML)	9100769
SML-SCL-G2 strip connector	9100791
SML-SCL clip adjustable set of 2 / 0-90° (for L450, L600, L900, L1200)	9100497
SML-SCL clip adjustable set of 3 / 0-90° (for L1500)	9100498
SML-SCL Magnet-Clip set of 2 (for L450, L600, L900, L1200)	9100492
SML-SCL Magnet-Clip set of 3 (for L1500)	9100499
Strip lock for connection cable male/female set of 2 (for LCR-SCL-SML)	9100780
SML-SCL-G2 strain relief for power jack connector	9100989

IMPORTANT NOTES

All technical parameters apply to the entire product. Due to the complex manufacturing process of light emitting diodes, the specified typical LED parameters are only purely statistical values and may deviate.

The specified type of use must be strictly adhered to. Deviations may affect the stability of the fixture. Please observe the information in the mounting instructions before using the products.

Mercury content	0,0 mg
Mercury-free	yes
Professional disposal according to WEEE	yes

NOTES TO THE LIFE TIME

Decisive factors for the life time are the ambient temperature and the operating temperature (Tc). Exceeding the permissible limits results in a substantial reduction of the lifetime and can even lead to the destruction of the products. The specified lifetime represents a statistical quantity.

NOTES TO ELECTRICAL AND PHOTOMETRIC DATA

Colour coordinates according to CIE 1931

Rated ambient temperature: $t_a = 25^\circ$

Measuring tolerance colour coordinates (x/y) +/- 0,005

Tolerance range of electrical / photometric data: +/- 10%

DISCLAIMER

Changes and errors excepted. Due to the continuous development of all products, technical and design changes can occur at any time. Make sure that you always use the latest version of the data sheet.

Further product data as well as current information can be found at www.lxpro.pl

5 YEARS
WARRANTY

